

Laser Marker

HITACHI
Inspire the Next

CO₂ Laser Marker

LM-C3000 Series





CO₂ Laser Marker LM-C300 Series

Hitachi new laser marker LM-C300 Series meets a wide variety of industrial coding requirements

Hitachi has provided for a high-level marking system solutions in a wide range of production lines. And now, the LM-C300 Series CO₂-based laser marker is developed with Hitachi's experiences and know-hows.

Simple and intuitive operation

Stable operation by new cooling system is realized.

In protection structure, IP54 is equipped as standard.

The LM-C300 Series has literally become the well-engineered laser marker in the marking technology.



- Easy Operation
- Speed & Quality
- Reliability
- Safety

Easy Operation

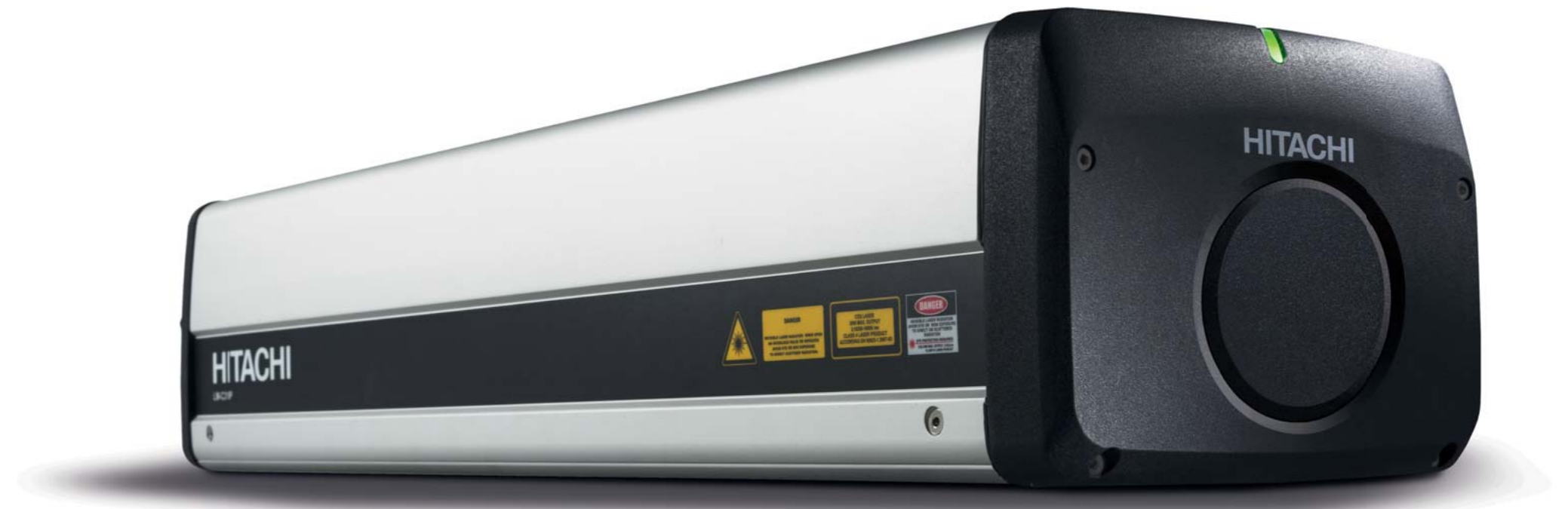

Touch Screen [option]

Our new, icon-based 10" full-color Touch Screen provides easy and intuitive operation. The WYSIWYG* design provides stress-free operation by displaying the print data and settings immediately. The Touch Screen is easy to use both in-handheld and on-the-equipment configurations.

* What You See Is What You Get

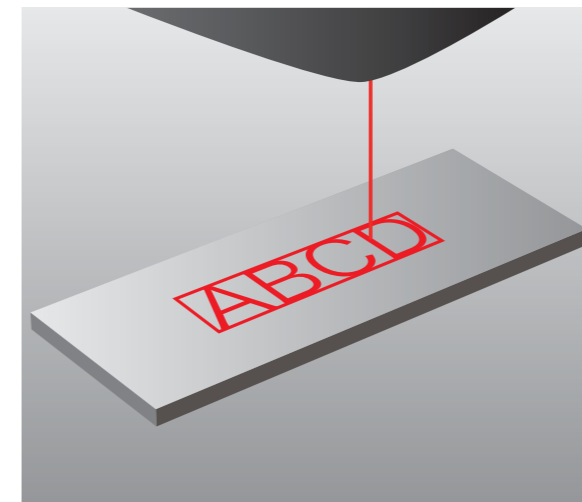

Guide laser feature [option]

By scanning the red guide laser, the print contents and the print positions can be checked on the object.

Control with Laser Application [option]

The LM-C300 Series can also be operated with the Laser Application. Windows®-based application* supports all kinds of operations that prepare and save the print data, create and modify the fonts, edit logo data and download the laser setups for individual products.

* HIKARI-SCAN

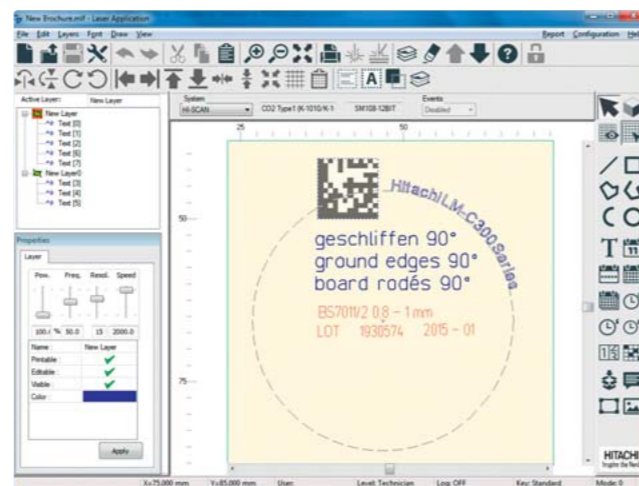

Pointer feature [option]

The red laser pointer makes it easy to check the center of the print.

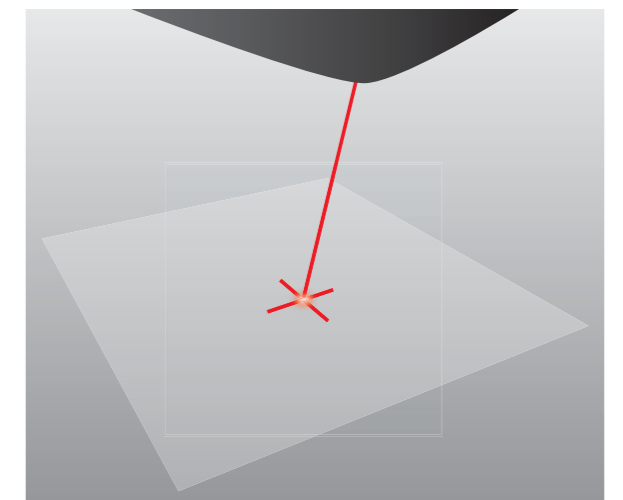

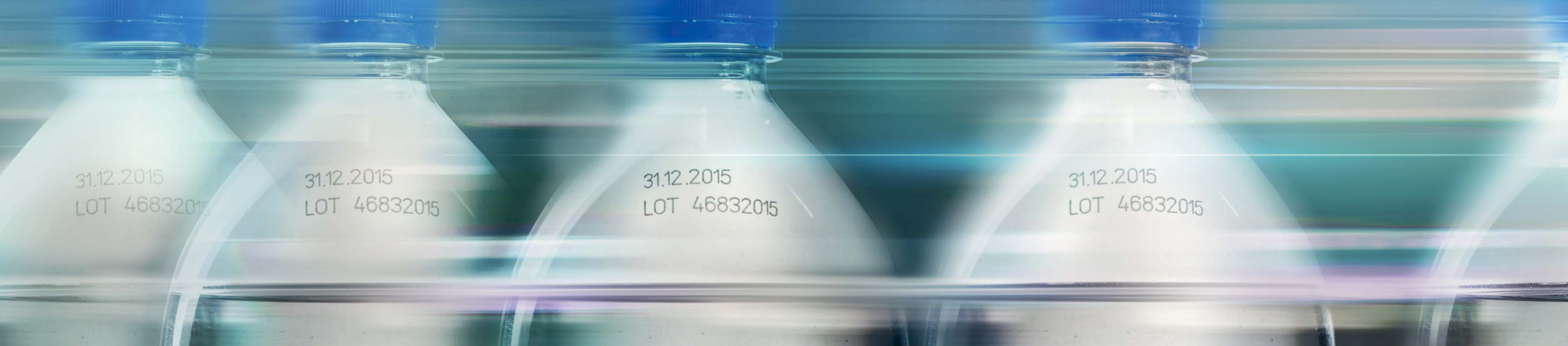

Speed & Quality

High speed coding at 600 cps*

The LM-C300 Series is capable of printing up to 600 cps (characters per second). It realizes significant reduction of print time and can print on a variety of objects which are moving at high-speed on production lines, not to mention the stationary objects.

* In case of printing alphanumeric characters of 2mm height and 1mm width. Depends on the work.

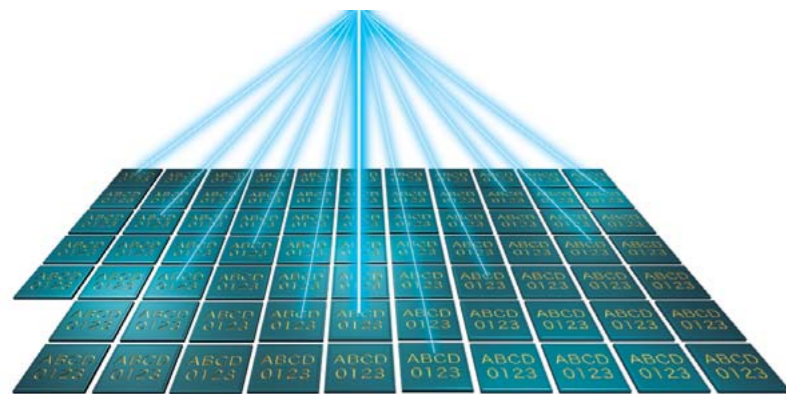

Print sample

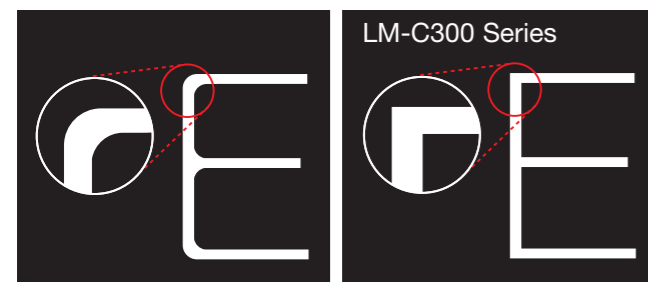

Sharp printing by excellent scan control

High-performance Galvano-scanner realizes high-quality and high-speed printing* and can properly adjust the edges and the curved lines of each character.

* Depends on the scan speed.

Intersection adjustment

The LM-C300 Series offers a support function for crossless lines, which prevents the deep marking where the lines intersect or overlap and the distortion of the shape of characters printed.

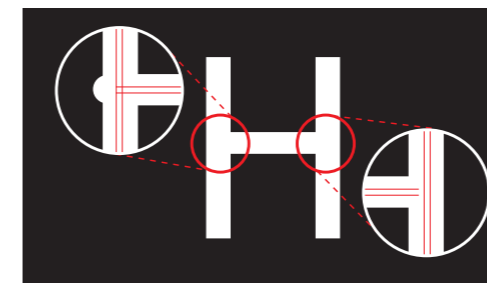

Depth control

Laser output control system can control the power of marking at areas susceptible to deep marking such as beginning of the line, end of the line and intersection of the lines.

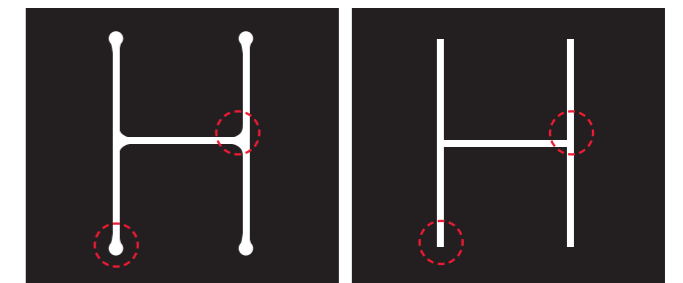

Font editor

Each character of the fonts can be manually modified and aligned to the application requirements. In order to prevent pin holes, the points of intersections and deep markings can be adjusted on the font data.

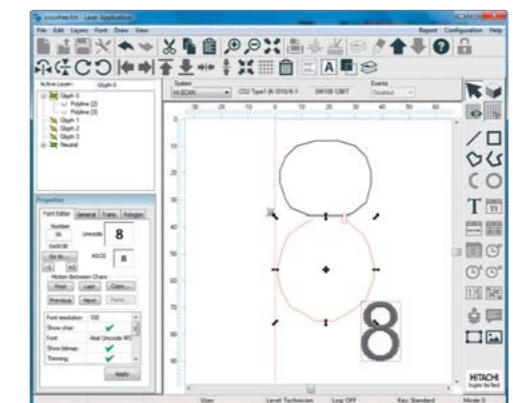

±3% (typ.*) Stable laser output [30W]

Practically-stable printing is performed because of small fluctuation of laser output.

* After two minutes (typ.) at 95% Duty cycle.
(=>15°C to <=40°C Ambient, humidity >0% <95%, non-condensing)

Reliability

New cooling system

By supplying the air through the whole laser tube of the heart of laser marker, it can cool the laser tube effectively, lower the temperature rise and improve the laser output stability. With the new cooling system, the print quality variations can be minimized, and the stable and sharp marking is realized.

IP54 is equipped as standard in protection structure

In addition to the dust-tight construction of the scanner, the single cover structure of the laser tube is now adopted, and it realizes the effective cooling system and the sealed structure. The LM-C300 Series equips IP54* as standard in protection structure and can be used reliably even in harsh environments.

* International Protection under the provisions of International Electrotechnical Commission.

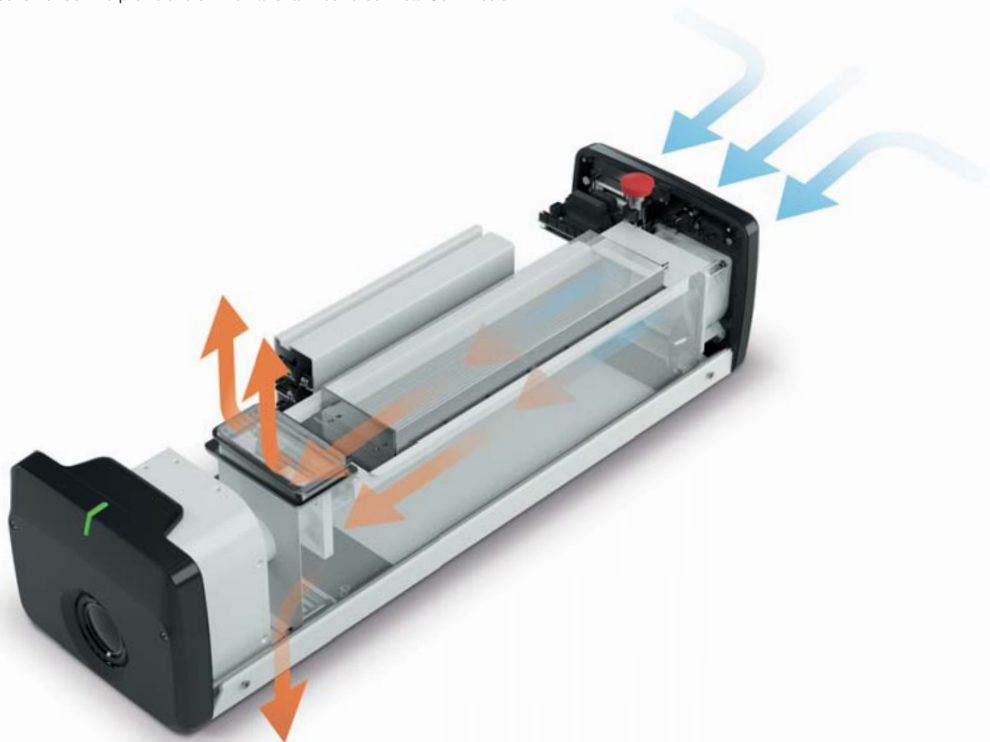

Air flow

Blowing the air out from the side of lens keeps particulates off the focal lens and keeps the lens clean. It reduces the loss of laser output and realizes the stable marking.*

* Effect will vary depending on print conditions.

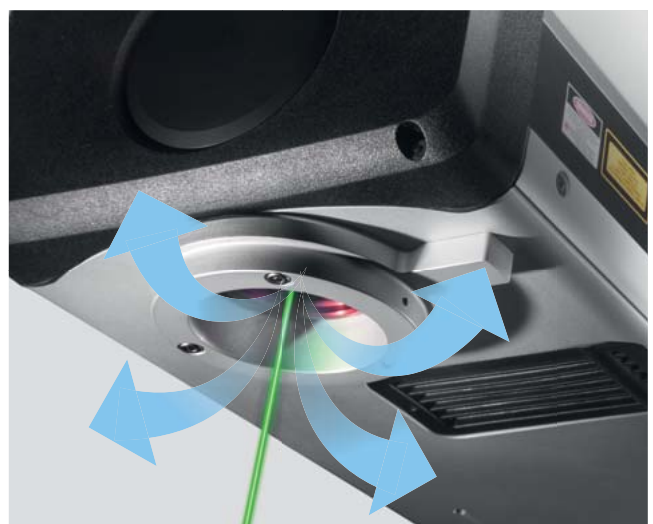

Safety

Laser status indicator

Three-color laser status indicator is adopted on the head of laser marker. It is the reliable design which makes it possible to know the conditions of laser marker at first sight.



Ready
[Green]



Marking
[Blue]



Alarm
[Orange]

Shutter

The electromechanical shutter will block the laser beam. The reliable design ensures high safety performance.

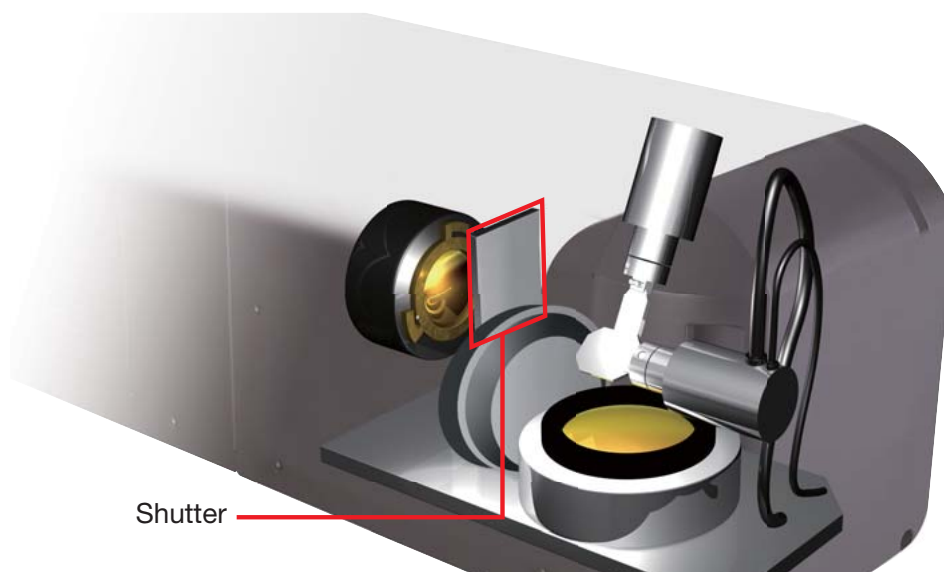

Packaging materials

The world of packaging consists of a huge variety of different technologies and materials including paper, corrugated cardboard, glass, rigid plastics, flexible foils, films etc. To handle this diversity of materials Hitachi LM-C300 Series comes with two different output power levels of 10W-class and 30W-class and with three different wavelengths of 9.3 μ m, 10.2 μ m and 10.6 μ m. Remember each material or composition does adopt, absorb and reflect light in a different way.



Paper, Cardboard and Glass – 10.6 μ m Wavelength

The CO₂ laser radiation of 10.6 μ m wavelength gets well absorbed in applications that process materials ranging from thin paper to cardboard packaging. Extremely good print results are also achieved on glass products. This wavelength is the most common one available with CO₂ lasers and perfectly suits the majority of packaging applications.



PET – 9.3 μ m Wavelength

Perfectly matched for the head absorption of plastics like PET (Polyethylene Terephthalate), the 9.3 μ m wavelength laser allows marking on plastic surfaces by smoothly melting the surface layer without creating pinholes or cracking the inner structure. This is the ideal solution for the family of polyesters of thermoplastic resins. PET is wide-spreading in the beverage industry and is mostly used for producing bottles.



Film and Foil – 10.2 μ m Wavelength

The 10.2 μ m wavelength is ideally suited to marking on thin films and any types of packaging foils. Best results can be expected on painted films and foils with a thin ink layer on top. The laser energy removes the ink and generates a contrast with the next bottom layer, e. g. with the metalized composite or aluminum. Packaging materials which absorb this wavelength very well and therefore generate the best CO₂-Laser print quality are PE, HDPE, LDPE, PP, OPP, OPA, PA, PMMA, POM, PUR, ABS and PVC.

Specifications

Hitachi Series	LM-C300S (Without Beam Expander)		LM-C300P (With a Beam Expander)	
Model	LM-C310S	LM-C330S	LM-C310P	LM-C330P
Laser Technology	CO ₂ Laser, Class 4 laser			
Laser Power & Laser Wavelength	10 W 10.6 μm (e. g. Paper, Cardboard, Glass)	30 W 10.6 μm (e. g. Paper, Cardboard, Glass) 25 W 10.2 μm (e. g. OPP, PP, PE) 20 W 9.3 μm (e. g. PET)	10 W 10.6 μm (e. g. Paper, Cardboard, Glass)	30 W 10.6 μm (e. g. Paper, Cardboard, Glass) 25 W 10.2 μm (e. g. OPP, PP, PE) 20 W 9.3 μm (e. g. PET)
Marking Area (mm) *1	40 × 40 60 × 60 *2 75 × 75 100 × 100 150 × 150 200 × 200 250 × 250		40 × 40 60 × 60 75 × 75 100 × 100 *2 150 × 150 200 × 200 250 × 250	
Guide Laser, Pointer (Options)	Red semiconductor, Wavelength 655 nm, Class 2 Laser			
User Interface	Touch Screen (Option) / Laser Application (Option)			
Shutter	Electromechanical Shutter			
Protection	IP 54			
Weight	17 kg	25 kg	17 kg	25 kg
Dimension (Width × Height × Depth)	196 × 148 × 698 (mm)	216 × 179 × 709 (mm)	196 × 148 × 698 (mm)	216 × 179 × 709 (mm)
Laser Status Indicator	Ready (Green) / Marking (Blue) / Alarm (Orange)			
Power Supply	AC100 to 120V ± 10 %, AC200 to 240 V ± 10 % (50 / 60 Hz)			
Power Consumption	300 VA	600 VA	300 VA	600 VA
Operating Temperature Range	5 to 40 °C (No dew condensation or freezing allowed.)			
Operating Humidity Range	35 to 95 % RH (No dew condensation or freezing allowed.)			

*1 Vary corresponding lens with the wavelength
*2 Recommended models

Global standards

■ Conformity to Global standards
CE, UL, c-UL.



Dimensions of Laser Marker (mm)

LM-C310S, LM-C310P

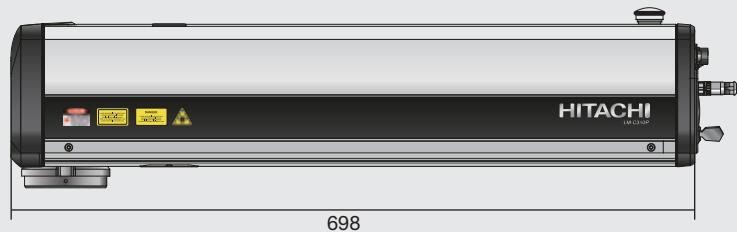
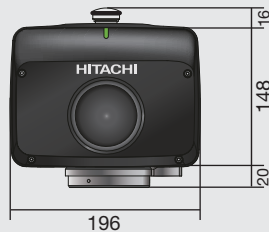

LM-C330S, LM-C330P

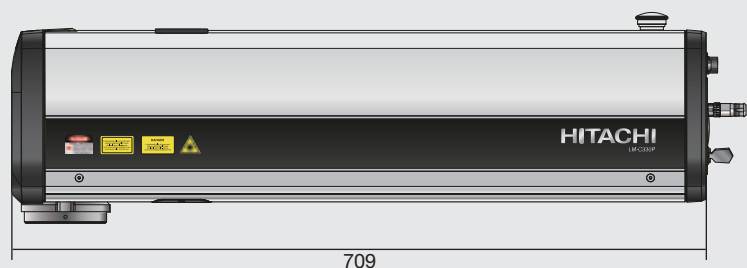



PRECAUTIONS FOR USE



About Laser Beam

- This product is classified as a class 4 Laser Product in IEC. Never stare at or touch the direct laser beam and its reflections.
- The laser used by this product generates infrared light that is invisible to the human eyes. Use with particular caution when the laser is operating.

Recommendation for Use of Fume Extractor

- While marking is executed with this product, harmful gas or smoke may be generated depending on the objects to be marked. It may have a bad influence on the human body and the laser marker. Use a suitable type of fume extractor with consideration of the objects to be marked.

- Hitachi Industrial Equipment Systems Co., Ltd. (Hitachi) shall not be liable for any manufacturing loss, or any product damage due to trouble or malfunction of the laser marker.
- Hitachi continually improves products. The right, therefore, is reserved to alter the designs and/or specifications without giving prior notice.
- Information in this brochure is subject to change without notice.

 **Hitachi Industrial Equipment Systems Co., Ltd.**

For further information, please contact your nearest sales representative.